

Art.-Nr./Item no./N° d'Art. 670053-V04

1. a. Decke / Ceiling / plafond

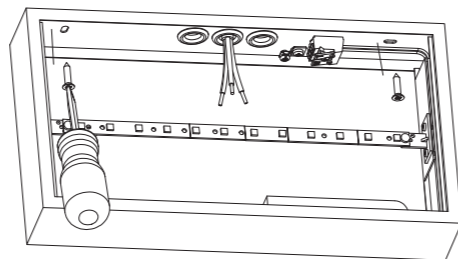

b. Wand / wall / mur

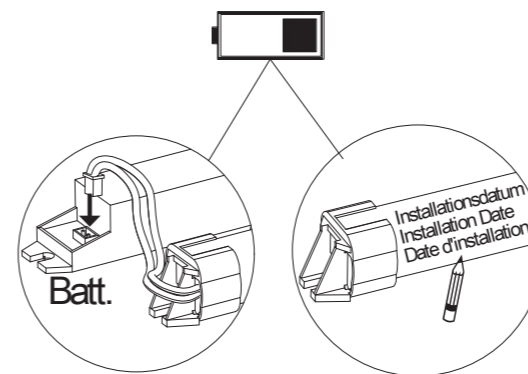
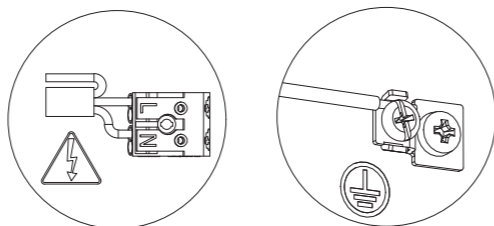
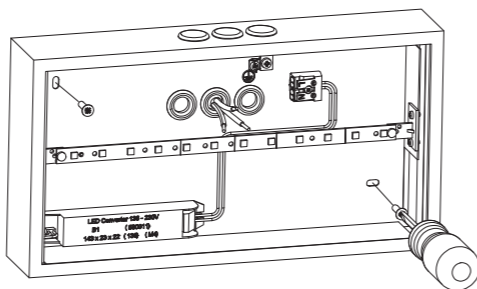

2.

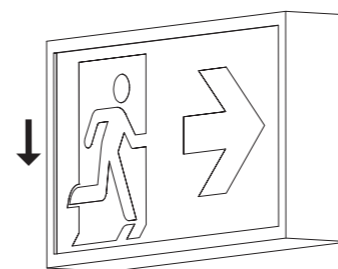
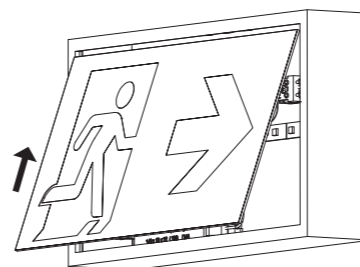

**Gehäuseausführung / Casing design / Configuration logement**  
**334 x 177 x 60 mm**  
**Wandmontage / wall installation / montage au mur**

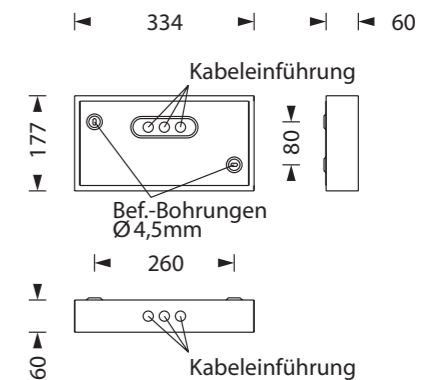

**Gehäuseausführung / Casing design / Configuration logement**  
**334 x 177 x 60 mm**  
**Deckenmontage / ceiling installation / montage au plafond**

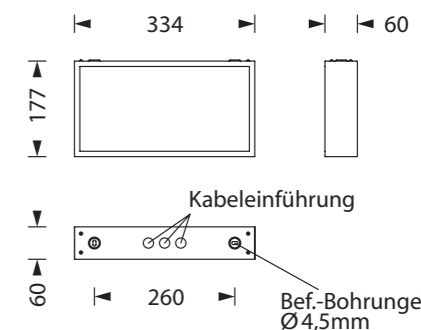

|  |   |
|--|---|
|  <b>Kabeleinführung</b>       |  <b>Bef. Bohrungen</b>     |
|  <b>Introduction de câble</b> |  <b>Perçages existants</b> |

3.

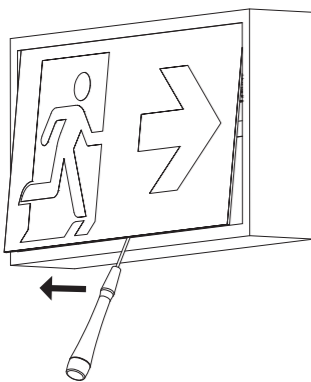
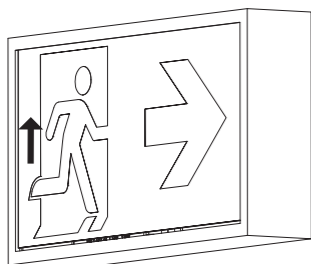

4.

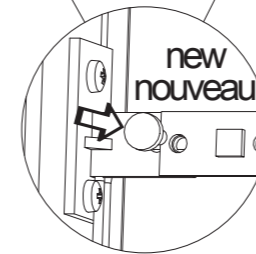
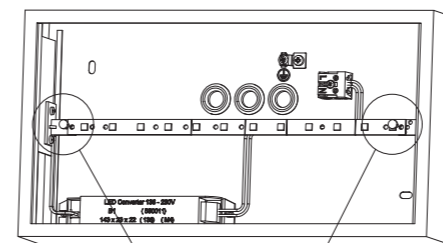
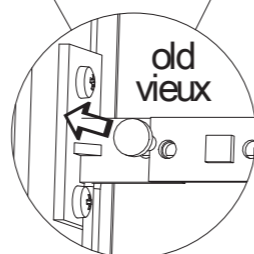
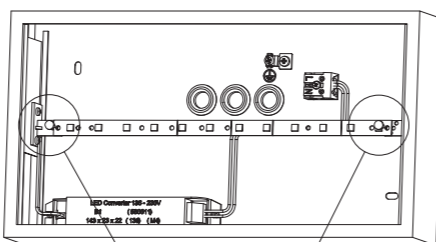

5.

